



Brother
Earth

Working with you for a better environment
www.brotherearth.com

Compact Machining Center
SPEEDIO

brother
at your side

NEW

S1000X1

Global Service Sites

Local dealers are available to provide services in each region, in addition to the sites below.

U. S. A.

**BROTHER INTERNATIONAL CORP.
MACHINE TOOLS DIV. TECHNICAL CENTER**
2200 North Stonington Avenue, Suite 270, Hoffman Estates, IL 60169, U.S.A.
PHONE:(1)224-653-8415 FAX:(1)224-653-8821

Thailand

**BROTHER COMMERCIAL THAILAND LTD.
MACHINE TOOLS TECHNICAL CENTER**
1232 Rama 9 Road, Suanluang Sub-District, Suanluang District,
Bangkok 10250, Thailand
PHONE:(66)2-374-6447 FAX:(66)2-374-2706

China

**BROTHER MACHINERY (SHANGHAI) LTD.
(MACHINE TOOLS DIV.) SHANGHAI TECHNICAL CENTER**
Room B, 3/F., No.567, West Tianshan Rd., ChangNing District,
Shanghai 200335, P.R.China
PHONE:(86)21-2225-6666 FAX:(86)21-2225-6688

China

**BROTHER MACHINERY (SHANGHAI) LTD.
CHONGQING BRANCH (MACHINE TOOLS DIV.) CHONGQING TECHNICAL CENTER**
Room 105, No.51 Xuefudadao, Nan'an District, Chongqing Province, 400074, P.R.China
PHONE:(86)23-6865-5600 FAX:(86)23-6865-5560

Germany

**BROTHER INTERNATIONALE INDUSTRIEMASCHINEN GmbH
MACHINE TOOLS DIVISION FRANKFURT TECHNICAL CENTER**
Hoechster Str.94, 65835 Liederbach, Germany
PHONE:(49)69-977-6708-0 FAX:(49)69-977-6708-80

India

**BROTHER INTERNATIONAL (INDIA) PVT LTD.
BANGALORE TECHNICAL CENTER**
Park Landing, Ground Floor, Municipal No.5AC-709, 2nd Block, HRBR Extension,
Bangalore - 560 043 Karnataka, India
PHONE:(91)80-6405-7999

China

**BROTHER MACHINERY (SHANGHAI) LTD.
DONGGUAN BRANCH (MACHINE TOOLS DIV.) DONGGUAN TECHNICAL CENTER**
1F, Fuyuan Business Center Building, No.1 Lane 13, Malyuan Road, Xin'an community,
Chang'an Town, Dongguan City, Guangdong Province, 523008, P.R.China
PHONE:(86)769-2238-1505 FAX:(86)769-2238-1506

Figures in brackets () are the country codes.

Specifications may be subject to change without any notice.

brother

BROTHER INDUSTRIES, LTD.
MACHINERY & SOLUTION COMPANY

1-5, Kitajizoyama, Noda-cho, Kariya-shi,
Aichi-ken 448-0803, Japan
PHONE: 81-566-95-0075
FAX : 81-566-25-3721

<http://www.brother.com>

The information in this catalogue is current as of May 2015. ver.1505





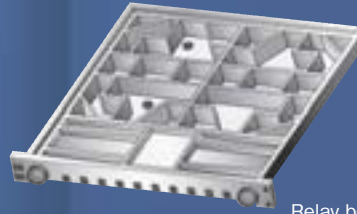

Basic specifications	Max. spindle speed (min ⁻¹)	10,000 10,000 high-torque (optional) 16,000 (optional)
Travels (mm)	X 1,000 Y 500 Z 300	
Tool storage capacity (pcs.)	14 / 21	
Rapid traverse rate (m/min)	X / Y / Z 50 / 50 / 56	
Required floor space (mm)	2,410 × 2,442	
BT dual contact spindle (BIG-PLUS)	Optional	
Coolant Through Spindle (CTS)	Optional	



Relay box



Timing chain cover



Cylinder head cover

Expanding coverage of #30 machine

"Machining larger workpieces using #30 machine"

The release of the S1000X1 machining center sees an override in the conventional machining areas of #30 machines.

Continuing in the spirit of overwhelming high productivity, the machine will launch a challenge to new machining areas, boosting our "Brother also in this process" concept.

SPEEDIO
S1000X1



Sufficient travels and table size

Increase in X- and Y-axes travels and expansion of the machining area have enabled large workpiece machining and large jig mounting, which were not possible on conventional #30 machines.

Travels :
X1,000 Y500

Work area size :
X1,100 Y500

Max. loading capacity :
400kg

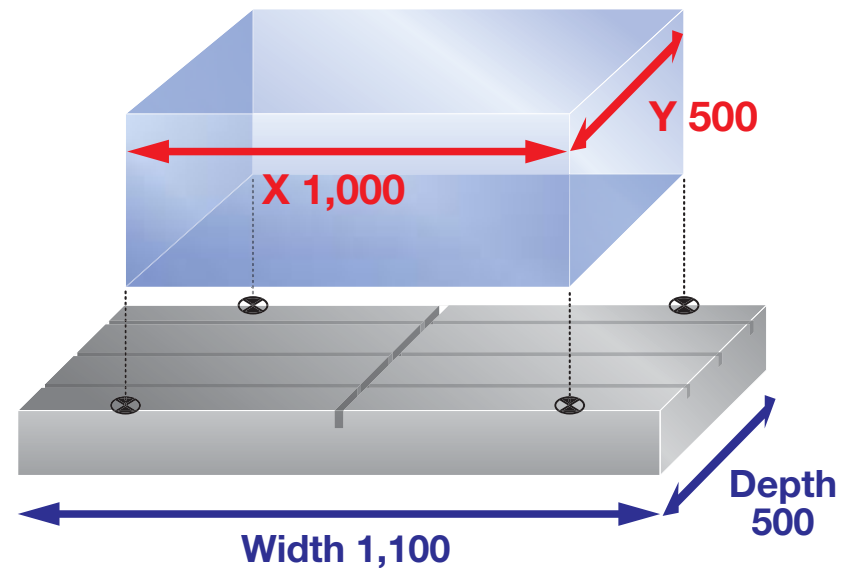

Mounting large jigs possible

A wider, longer jig area has been secured, enabling mounting of large jigs. 150 mm, 250 mm, and 350 mm high columns (optional) are available to meet customers' needs.

■ Mounting example 1

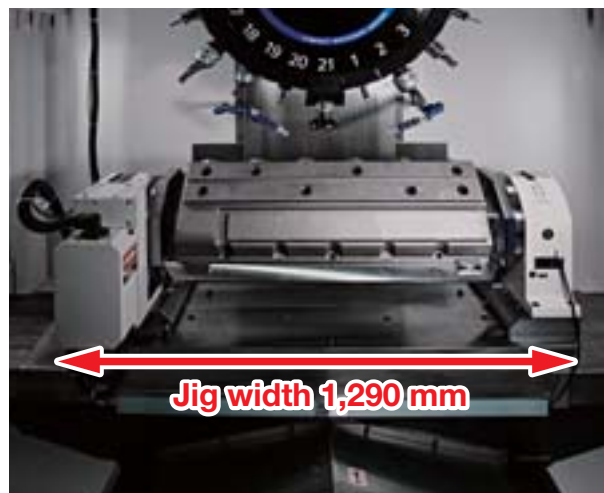

Rotary table diameter : $\phi 250$
Workpiece size : 830x264x135 (mm)

■ Mounting example 2

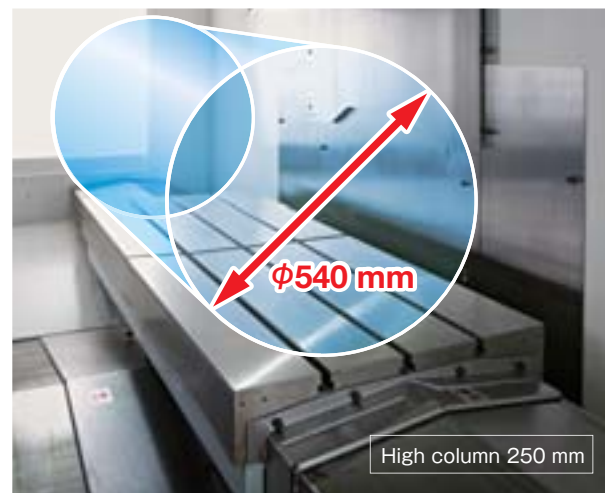

Trunnion-type fixture with a turning diameter of $\phi 540$ mm can be mounted.

High-speed and optimal operation control

■ Fast acceleration/deceleration spindle

Using a fast acceleration/deceleration spindle motor enables the spindle to start and stop in an extremely short time.

Spindle start/stop time : **0.15s**

*When using high-torque specs

■ Nonstop ATC

High-speed tool change has been achieved by optimizing and increasing the speed of spindle start/stop, Z-axis up/down, and magazine movement.

Chip — Chip : **1.4s**

Tool — Tool : **0.8s**

■ Simultaneous operation control

Wasted time has been further reduced by simultaneously performing tool change and positioning X/Y and additional axes.

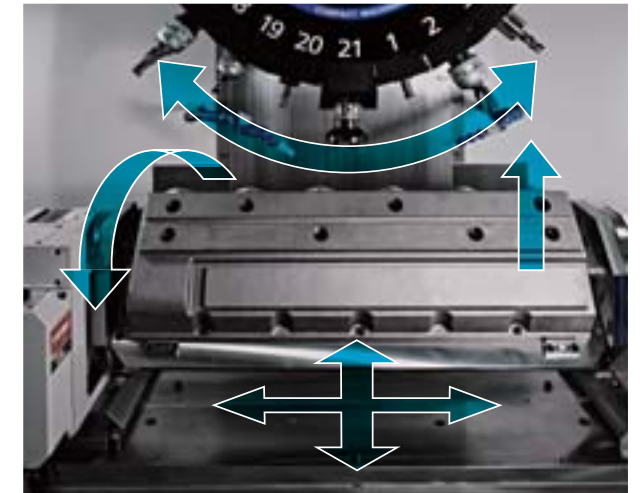

■ Highly-responsive servomotor

Delay in response has been reduced to almost zero by increasing the responsiveness of the servomotor. High-speed synchronized tapping at the fastest level in the world has been achieved.



Comparison of tapping cycle time

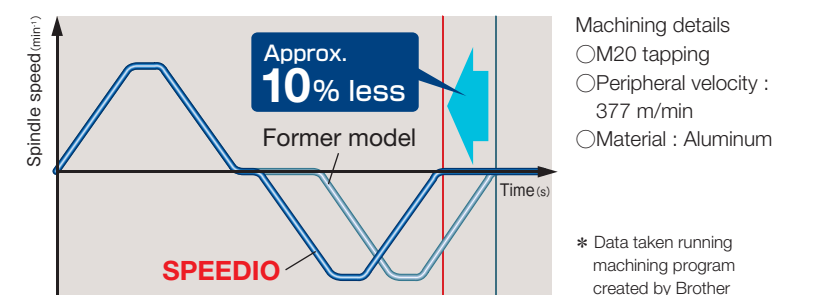

Comparison of cycle time

■ Program mainly consisting of drilling and tapping

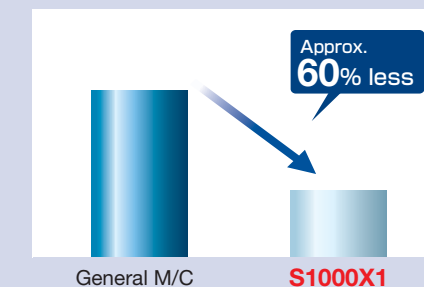

■ Program mainly consisting of milling and end milling

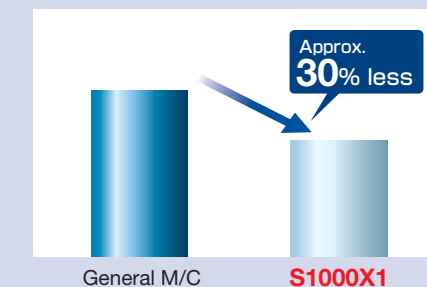

Compared to a machining center with the same machining area, Brother's original high-speed and optimal operation control results in overwhelming high productivity.

* Data taken running machining program created by Brother

Highly rigid structure

Backbone parts, such as the base, column, and table, have been specially designed through numerical analysis to secure high rigidity.

Column

High rigidity achieved through a review of the rib structure and expansion of the column width in response to an increase in the Y-axis travel

Table

Highly rigid to support large jigs, achieved by expanding the guide span and using a structure that suppresses deflection over the entire table

Base

High rigidity achieved through a review of the rib structure and an increase in the distance between base plates

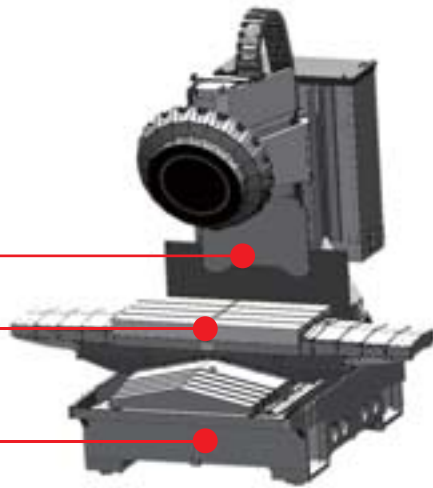

High-power spindle motor

Standard specifications

Torque in the medium- and high-speed range is high, enabling high efficiency machining for aluminum, steel etc.



Grooving using standard specs
Machining details
○Cutting amount : 150 cc/min
○Material : Carbon steel
(for ø16 end mill)

Spindle motor characteristics

Max. torque : **40Nm**
(momentary)
Max. output : **18.9kW**

High-torque specifications (optional)

Torque in the low-speed range has greatly improved, enabling heavy-duty machining at the highest level among #30 machines.



Large hole drilling using high-torque specs
Machining details
○Hole diameter : ø40 mm
○Material : Carbon steel

Spindle motor characteristics

Max. torque : **92Nm**
(momentary)
Max. output : **26.2kW**

Pursuit of high accuracy

High-speed and highly accurate three-dimensional machining has been achieved by Brother's original three-dimensional machining control equipped with the 200-block look-ahead function and smooth path offset function.

High accuracy mode BI : **Look-ahead 30 blocks**

High accuracy mode BII : **Look-ahead 200 blocks**

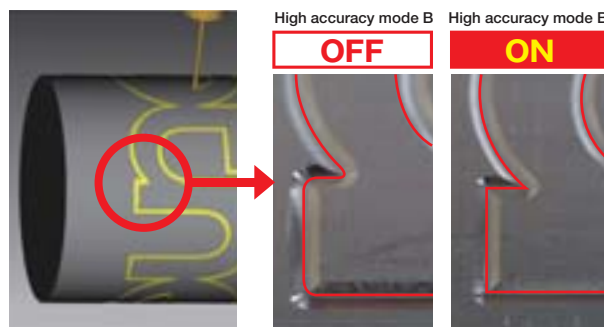

NC Unit

The machine is equipped with our original NC unit created through machine/controller integrated development. Usability has been further improved by expanding operation and maintenance functions and enhancing the system capacity.

Shortcut keys

Equipped with a "shortcut" function so you can quickly open the screen you want to view

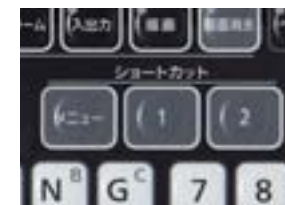

USB interface

In addition to high-speed file transfer, programs in the USB memory can be run directly or data, such as data measured by the touch probe, can be output.



Machining support functions

Equipped with machining support functions, such as torque waveform display, high accuracy mode, and automatic heat expansion compensation.

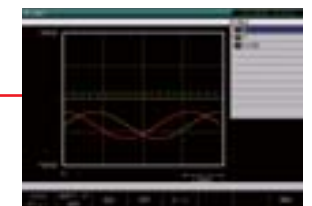

System capacity

Standard equipped with PLC. Input and output points can be expanded to up to 1,024 points each (optional).



Accessibility

Interlocking double doors are used. This provides a wider door opening width, improving workability.

Door opening width : **1,150mm**

The best table position has been secured so that the operator can perform setup change comfortably.

From front of machine to front of table : **226mm**

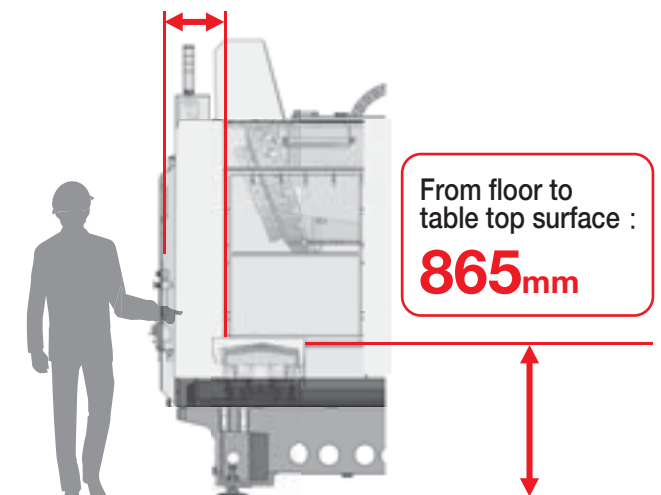

From floor to table top surface : **865mm**

High reliability

Chip discharge performance has been improved along with the expansion of the machining area. In addition, the machine is equipped with a variety of functions, such as air-assisted tool washing, to improve reliability.



■ Chip shower



■ Roof shape telescopic cover

Through the installation of two chip shower pumps to double the flow rate, and using roof shape telescopic covers for the X/Y-axes, chips are quickly discharged from the machining area.



■ Air-assisted tool washing (optional)

High discharge pressure prevents chips becoming attached to the holder.



■ Top cover (optional)

Separates the machining area from the machine room.



■ Motor insulation resistance measurement function

Detects motor failure in advance.



■ Maintenance notice function

Notifies operators of maintenance requirements, such as greasing.

High environmental performance

In addition to low power and air consumption, the machine is equipped with a power regeneration system and a variety of energy saving functions, achieving high environmental performance.

■ Power consumption for one cycle

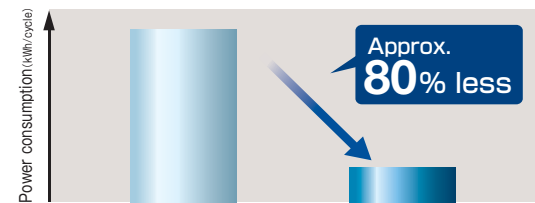

* Data taken running machining program created by Brother



LED type work light (optional)



Energy saving pump

■ The SPEEDIO is an earth-friendly machine equipped with a variety of energy-saving functions.

- **Automatic coolant off** : Turns off the coolant pump when the preset time elapses.
- **Standby mode** : Turns off the servomotor when the machine is not operated for the preset time.
- **Automatic work light off** : Turns off the work light when the preset time elapses.
- **Automatic power off** : Turns off the power at the preset time.

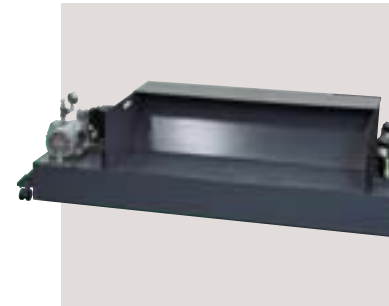

Coolant unit

A large 200L tank is available. (Photo : Tank with CTS)

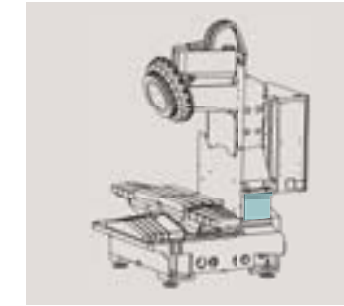

High column (150 mm, 250 mm, 350 mm)

150 mm, 250 mm, and 350 mm high columns are available to meet customers' needs.



Manual pulse generator

A cable is provided for the manual pulse generator, making setup easier.



Automatic oil lubricator / Automatic grease lubricator

Regularly applies oil or grease to all lubricating points on the three axes. * Manual greasing is required for the standard specification model.



Coolant Through Spindle (CTS)

1.5 MPa CTS is ideal for deep drilling and high-speed machining. The back washing system automatically washes the filter to prevent it from clogging, enabling longer continuous operation without filter replacement. * Please consult Brother separately for 3 MPa CTS.

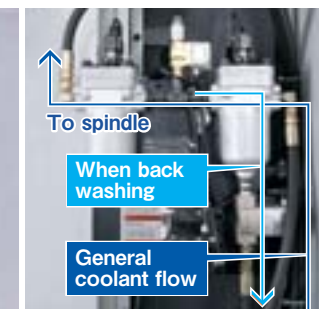

Automatic door (motor-driven)

Interlocking double doors are used, achieving smooth operation.

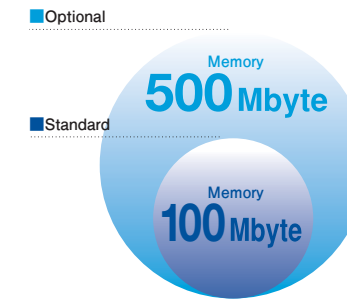

Memory expansion

Memory can be expanded to up to 500 Mbytes.



B-axis cord (1 axis, 2 axes)

Multi-face machining is possible by adding one or two axes.

Optional specifications

- Coolant unit
 - ①200L With chip shower and valve Pump : 250W x 3
 - ②200L for CTS With chip shower, CTS, and valve Pump : 250W x 3 + 650W
- Coolant Through Spindle(CTS)
- Mesh basket for chips
- Tool washing (air-assisted type)
- Tool breakage detector (touch type)
- Chip shower
- Cleaning gun
- Jig shower valve unit
- Back washing system (for CTS)
- Automatic oil lubricator
- Automatic grease lubricator
- LED type work light (1 or 2 lamps)
- Indicator light (1, 2, or 3 lamps)
- Automatic door (motor-driven)
- Area sensor
- Specified color
- Manual pulse generator
- B-axis cord (1 axis, 2 axes)
- Spindle override
- High column (150 mm, 250 mm, 350 mm)
- Grip cover
- Top cover
- Side cover (transparent board type)
- RS232C (25 pin) for control box
- Expansion I/O board (EXIO board)
 - ①EXIO board assembly *2
 - ②Additional EXIO board assembly
- Switch panel (6 holes, 10 holes)
- Memory expansion (approx. 500 Mbytes)
- High accuracy mode Bill (look-ahead 200 blocks, smooth path offset)
- Submicron command *1
- Interrupt type macro
- High-speed processing *1
- Rotary fixture offset
- Fieldbus *2
 - ① CC-Link (remote device station)
 - ② PROFIBUS DP (slave)
 - ③ DeviceNet (slave)
- PLC programming software (For Windows® XP, Vista, and 7)

Windows® is a trademark or registered trademark of Microsoft Corporation in the United States and/or other countries. *Please contact your Brother dealer for details.

*1 When the submicron command or high-speed processing is selected, changing to the conversation program is disabled. *2 When the fieldbus is selected, the EXIO board assembly cannot be selected.

External Dimensions

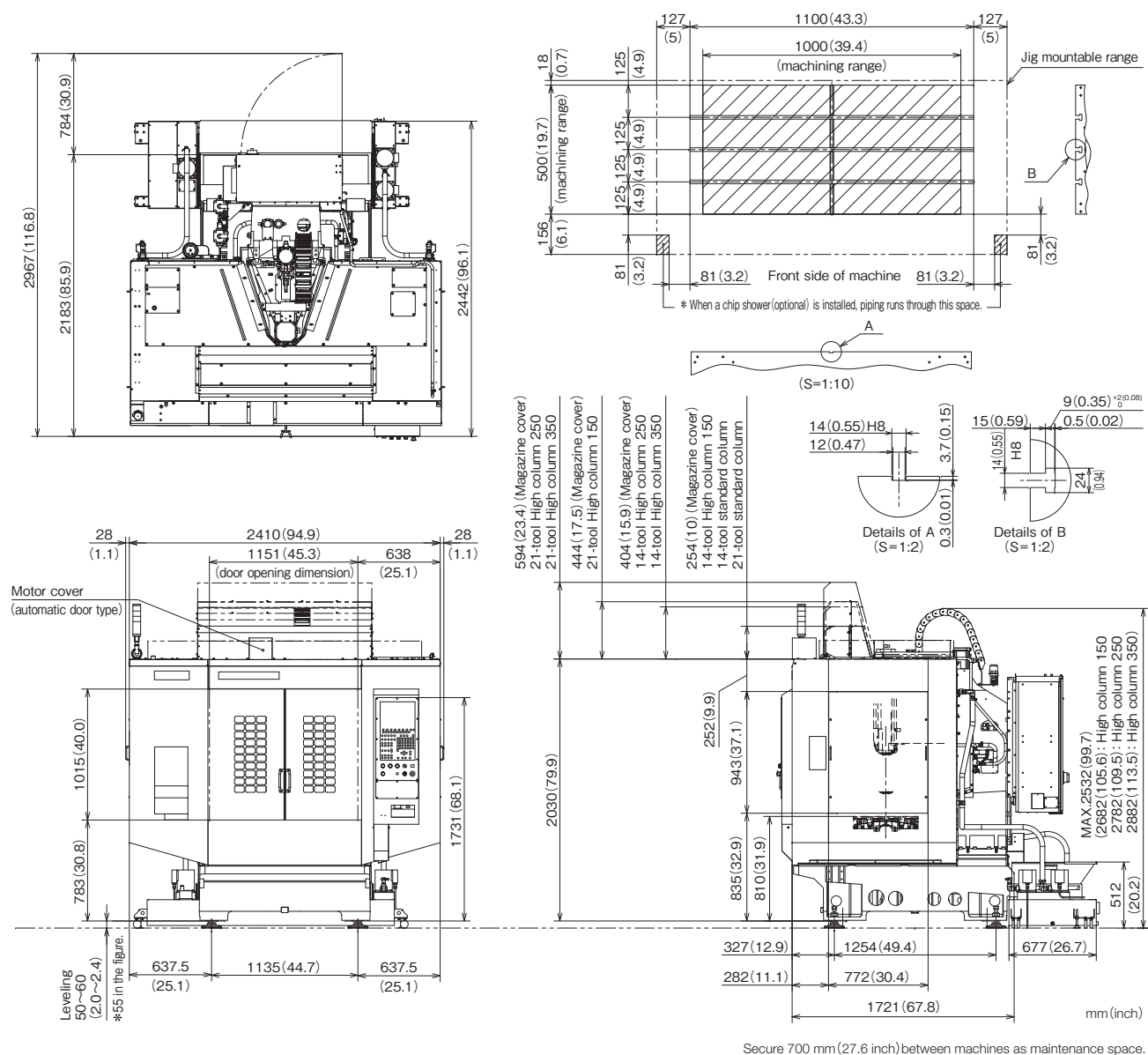

Machining capability

		ADC	Cast iron	Carbon steel
Drilling Tool diameter mm (inch) x Feed mm (inch)/rev	10,000min ⁻¹	D32(1.26) × 0.2(0.008)	D28(1.1) × 0.15(0.006)	D25(0.98) × 0.1(0.004)
	10,000min ⁻¹ high-torque	D40(1.57) × 0.2(0.008) D30(1.18) × 0.7(0.03)	D34(1.34) × 0.15(0.006) D26(1.02) × 0.4(0.02)	D30(1.18) × 0.15(0.006) D26(1.02) × 0.25(0.01)
	16,000min ⁻¹	D24(0.94) × 0.2(0.008)	D22(0.87) × 0.15(0.006)	D18(0.71) × 0.1(0.004)
Tapping Tool diameter mm (inch) x Pitch mm (inch)	10,000min ⁻¹	M27 × 3.0(1-8UNC)	M24 × 3.0(7/8-9UNC)	M16 × 2.0(5/8-11UNC)
	10,000min ⁻¹ high-torque	M39 × 4.0(1 1/2-6UNC)	M33 × 3.5(1 1/4-7UNC)	M27 × 3.0(1-8UNC)
	16,000min ⁻¹	M22 × 2.5(7/8-9UNC)	M18 × 2.5(5/8-11UNC)	M14 × 2.0(1/2-13UNC)
Facing Cutting amount cm ³ /min (inch ³ /min): Cutting width mm (inch) x Cutting depth mm (inch) x Feed rate mm/min (inch/min)	10,000min ⁻¹	960 : 100 × 3.2 × 3,000 (58.6 : 3.94 × 0.13 × 118.1)	137 : 40 × 6.0 × 573 (8.4 : 1.57 × 0.24 × 22.6)	100 : 40 × 5.2 × 484 (6.1 : 1.57 × 0.2 × 19.1)
	10,000min ⁻¹ high-torque	1,700 : 100 × 5.7 × 3,000 (102.4 : 3.94 × 0.22 × 118.1)	137 : 40 × 6.0 × 573 (8.4 : 1.57 × 0.24 × 22.6)	100 : 40 × 5.2 × 484 (6.1 : 1.57 × 0.2 × 19.1)
	16,000min ⁻¹	660 : 100 × 2.2 × 3,000 (40.3 : 3.94 × 0.09 × 118.1)	73 : 40 × 3.2 × 573 (4.5 : 1.57 × 0.13 × 22.6)	48 : 40 × 2.5 × 484 (2.9 : 1.57 × 0.1 × 19.1)

* The data is Brother's actual test data.

Item	S1000X1		
CNC Unit	CNC-C00		
Travels	X axis	mm (inch)	1,000 (39.4)
	Y axis	mm (inch)	500 (19.7)
	Z axis	mm (inch)	300 (11.8)
Table	Distance between table top and spindle nose end	mm (inch)	180~480 (7.1~18.9)
	Work area size	mm (inch)	1,100 × 500 (43.3 × 19.7)
	Max.loading capacity (uniform load)	kg (lbs)	300 [400 *6] [661 [881 *6]]
Spindle	Spindle speed	min ⁻¹	10,000min ⁻¹ specifications : 10~10,000 16,000min ⁻¹ specifications (optional) : 16~16,000 10,000min ⁻¹ high-torque specifications (optional) : 10~10,000
	Speed during tapping	min ⁻¹	MAX. 6,000
	Tapered hole		7/24 tapered No.30
Feed rate	BT dual contact system (BIG-PLUS)		Optional
	Coolant Through Spindle (CTS)		Optional
	Rapid traverse rate (XYZ-area)	m/min (inch/min)	50 × 50 × 56 (1,969 × 1,969 × 2,205)
ATC unit	Cutting feed rate	mm/min (inch/min)	X, Y, Z axis : 1~30,000 (0.04 ~ 1,181) *7
	Tool shank type		MAS-BT30
	Pull stad type *4		MAS-P30T-2
Tool change time *5	Tool storage capacity	pcs.	14 / 21
	Max. tool length	mm (inch)	250 (9.8)
	Max. tool diameter	mm (inch)	110 (4.3)
Electric motor	Max. tool weight *1	kg (lbs)	3.0 (6.6) / Tool (TOTAL TOOL WEIGHT : 25 (55.1) for 14 tools, 35 (77.2) for 21 tools)
	Tool selection method		Random shortcut method
	Tool To Tool	sec.	0.8
Power source	Chip To Chip	sec.	1.4
	Cut To Cut	sec.	1.2
	Main spindle motor (10min/continuous) *2	kW	10,000min ⁻¹ specifications : 10.1 / 6.7 16,000min ⁻¹ specifications (optional) : 7.4 / 4.9 10,000min ⁻¹ high-torque specifications (optional) : 12.8 / 8.8
Machining dimensions	Axis feed motor	kW	X, Y axis : 1.0 Z axis : 2.0
	Power supply		AC V±10%, 50/60Hz±1Hz
	Power capacity (continuous)	kVA	10,000min ⁻¹ specifications : 9.5 16,000min ⁻¹ specifications (optional) : 9.5 10,000min ⁻¹ high-torque specifications (optional) : 10.4
Accuracy *3	Air supply	MPa	0.4~0.6 (recommended value: 0.5MPa *8)
	Regular air pressure	MPa	
	Required flow	L/min	45
Front door	Height	mm (inch)	2,532 (99.7)
	Required floor space [with control unit door open]	mm (inch)	2,410×2442 [2,692] (94.9×96.1 [106.0])
	Weight	kg (lbs)	3,300 (7,275)
Standard accessories	Accuracy of bidirectional axis positioning (ISO230-2:2006)	mm (inch)	0.006~0.020 (0.00024 ~ 0.00079)
	Repeatability of bidirectional axis positioning (ISO230-2:2006)	mm (inch)	Less than 0.004 (0.00016)
	2doors		
Instruction Manual (1 set), anchor bolts (4 pcs.), leveling bolts (4 pcs.), machine cover (manual door)			

*1. Actual tool weight differs depending on the configuration and center of gravity. The figures shown here are for reference only. *2. Spindle motor output differs depending on the spindle speed. *3. Measured in compliance with ISO standards and Brother standards. *4. Brother specifications apply to the pull studs for CTS. *5. Measured in compliance with JIS B6336-9 and MAS011-1987. *6. Acceleration must be adjusted for X and Y axes. *7. When using high accuracy mode B. (Non high accuracy mode B) X,Y axis : 1~10,000mm/min. Z axis : 1~20,000mm/min. *8. Regular air pressure varies depending on the machine specifications, machining program details, or use of peripheral equipment. Set the pressure higher than the recommended value.

NC unit specifications	
CNC model	CNC-C00
Control axes	5 axes (X,Y,Z, two additional axes)
Simultaneously controlled axes	Positioning 5 axes (X,Y,Z,A,B)
	Interpolation Linear : 4 axes (X,Y,Z one additional axis) Circular : 2 axes Helical/conical : 3 axes (X,Y,Z)
Least input increment	0.001mm, 0.0001inch, 0.001 deg.
Max. programmable dimension	±9999.999mm, ±999.9999 inch
Display	12.1-inch color LCD
Memory capacity	Approx. 100 Mbytes (Total capacity of program and data bank)
External communication	USB memory interface, Ethernet, RS232C (optional)
No. of registrable programs	4,000 (Total capacity of program and data bank)
Program format	NC language, conversation (changed by parameter), conversation from conversation program to NC language program available

Standard NC functions		
<ul style="list-style-type: none"> Absolute / incremental Inch / metric Corner C / Corner R Rotational transformation Synchronized tap Coordinate system setting Dry run Restart Backlash compensation Rapid traverse override Cutting feed override Alarm history (1,000 pieces) Start log Machine lock Computer remote Built-in PLC Motor insulation resistance measurement Operation log High accuracy mode All Tool length measurement Tool life management / spare tool Background editing 	<ul style="list-style-type: none"> Graphic display Subprogram Helical / conical interpolation Tool washing filter with filter clogging detection Automatic power off (energy saving function) Servomotor off standby mode (energy saving function) Chip shower off delay Automatic coolant off (energy saving function) Automatic work light off (energy saving function) Heat expansion compensation system II (X,Y,Z axes) Tap return function Automatic workpiece measurement *1 Waveform display Operation level External input signal key High accuracy mode BI (look-ahead 30blocks) 	<ul style="list-style-type: none"> (NC) Expanded workpiece coordinate system Scaling Mirror image Menu programming Program compensation Tool length compensation Cutter compensation Macro function Local coordinate system One-way positioning Operation in tape mode (Conversation) Operation program Schedule program Automatic tool selection Automatic cutting condition setting Automatic tool length compensation setting Automatic cutter compensation setting Automatic calculation of unknown number input Machining order control

*1 When program size is bigger than 2 Mbytes, machine works with extended memory operation. *2 Ethernet is a trademark or registered trademark of XEROX in the United States.

*1 Measuring instrument needs to be prepared by users. *2 When the submicron command is used, changing to the conversation program is disabled. *3 Minute block processing time can be changed. As there are some restrictions, please contact your local distributor for details. *Functions listed under (NC) and (Conversation) are available only for NC programs and conversation programs respectively.

Optional NC functions		
<ul style="list-style-type: none"> Memory expansion (Approx. 500 Mbytes) High accuracy mode BI (look-ahead 200 blocks, smooth path offset) Spindle override 	<ul style="list-style-type: none"> (NC) Submicron command *2 Interrupt type macro Rotary fixture offset High-speed processing *3 	